



**OVAKO**

# **OVAKO MINING AND CONSTRUCTION SYSTEMS**

**OPTIMIZED STEEL FOR PROFITABLE PERFORMANCE**

# OPTIMIZED STEEL GRADES FOR THE TOUGHEST LOADS

**Extreme fatigue. Heavy wear. Constant abrasion. Whatever mining or construction systems you're fabricating, every load demands a specific solution. At Ovako, we can deliver the optimal steels for any load case or processing route. All to give you a tailored product that makes the most of your processing operations, while extending your equipment's life in the field.**

Thanks to our decades of experience serving leading manufacturers worldwide, we're able to tailor the most cost-effective and reliable products for a variety of mining and construction applications. These include all parts used in systems for percussive and rotary drilling (including tooling systems, described in a separate brochure) such as continuous mining, PAT tool holders, hammers and tools, hydraulic breaker components, cutters, tunnel boring machines and more. Special parts such as rock bolt material for underground safety are also part of our broad and expanding range of superior steel grades.

## Load case

### The right properties for your load case

Every Ovako steel is the result of extensive analysis of the dominant loads for various mining and construction components. For high frequency percussion, we optimize materials for fatigue resistance. For severe contact with hard rock or cuttings, we've developed one of the industry's broadest ranges of wear-resistant grades. And when it comes to heavy construction, few suppliers can match our portfolio of grades designed for pure mechanical strength.

Your most critical fatigue properties are meticulously controlled in our metallurgy. To simulate the loads, we measure fatigue resistance with RBF (Rotating Bending Fatigue) testing, among other methods that simulate a combination of wear mechanisms such as abrasion or erosion with various impact loads. The result is a fit-for-purpose steel with tightly controlled performance properties, making it possible to pre-calculate your components' lifetime for highly automated and repetitive processes.





### Processing needs

#### **The right grade and format for your processing route**

Many of our customers rely on near-net shape Ovako products to eliminate unnecessary machining of complex components. Others make use of our M-Steel® capabilities to enhance machining productivity. Whatever your processing route, our expansive range of grades, shapes and heat treatments ensures a nearly limitless variety of economical choices. Always with the uniform chemistry you need to guarantee repeatable results.

### Cost savings

#### **The right cost savings**

When it comes to cost savings, our three mills, in-house R&D and multiple sales organizations worldwide are always at your service. Together they've helped leading manufacturers everywhere to develop and select the optimal products, deliver with minimal lead times, and achieve total control of price and performance – from initial melt to final product.

# SUPERIOR SOLUTIONS FOR IMPACT, WEAR AND MECHANICAL LOADS

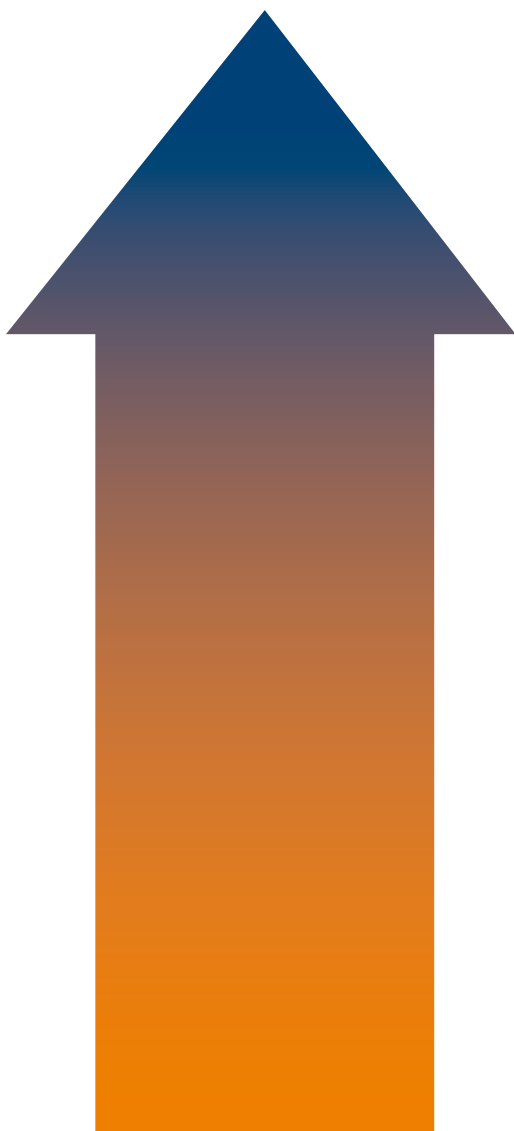

Load case	General and mechanical strength
Typical products	<b>Rock bolts, drill tubes, structural elements</b>
<b>YOUR SUPERIOR END PRODUCT</b>	<ul style="list-style-type: none"> <li>• Safe products from reliable steel</li> <li>• Predictable component lifespan</li> </ul>
<b>YOUR PROCESSING NEEDS</b>	<ul style="list-style-type: none"> <li>• Tailored steels for specific processes</li> <li>• Reliable and repeatable processing</li> <li>• Minimal machining time</li> </ul>
<b>OVAKO CUSTOMIZED SERVICES</b>	<ul style="list-style-type: none"> <li>• Simplified supply chain with EDI forecasting and order handling</li> <li>• Optimized lead times</li> <li>• Integrated stocking solutions</li> <li>• Complete status overview with OvaTrack</li> <li>• Standard Ovako 280 tubes in stock</li> </ul>
<b>OVAKO TAILORED PRODUCT GEOMETRIES</b>	<ul style="list-style-type: none"> <li>• Near-net-shape and pre-cut components</li> <li>• Wide range of sizes and formats</li> <li>• Ovako 280 Tube standard program</li> </ul>
<b>OVAKO MATERIAL CAPABILITIES</b>	<ul style="list-style-type: none"> <li>• Wide range of steel grades</li> <li>• Material properties tailored for your processing route</li> <li>• Tight chemical consistency for reliable automation</li> </ul>

**Ovako steel combines optimized materials, tailored geometries and integrated service solutions customized to your needs. Depending on your end product and dominant load case, our entire supply chain can be adapted to give your operations a lasting competitive edge.**

## Percussive/fatigue strength

### Pistons

- Extended lifespan and fatigue resistance
- Enabling increased energy input
- Tailor-made and fit-for-purpose (e.g. pistons)
- Predictable component lifespan

- Tailored steels for specific processes
- Reliable, repeatable processing

- Simplified supply chain with EDI forecasting and order handling
- Optimized lead times
- Integrated stocking solutions
- Complete status overview with OvaTrack

- Near-net-shape and pre-cut components
- Wide range of sizes and formats

- Ovako clean mining steels (IQ-Steel® and BQ-Steel®)
- Wide range of steel grades
- Material properties tailored for your processing route
- Tight chemical consistency for reliable automation

## Wear resistance

### PAT tools, continous miner, augers TBM cutters, hydraulic breakers

- Extended lifespan and wear resistance
- Competitive margins due to improved productivity
- Tailor-made, fit-for-purpose (e.g. pistons, TBM cutters)

- Cost-efficient machining with special profiles
- Avoid slitting of wide plates and subsequent yield loss
- Soft machining for improved efficiency
- Optimized hardness after Q&T

- Simplified supply chain with EDI forecasting and order handling
- Optimized lead times
- Integrated stocking solutions
- Complete status overview with OvaTrack

- Near-net-shape and special profile bars
- Wide range of sizes and formats
- Flat bar delivered in soft condition
- As-rolled hardness for optimized hardening

- Broad range of WR-Steel® grades for both "normal" wear and impact wear
- Material properties tailored for your processing route
- Tight chemical consistency for reliable automation

# SPECIALIZED STEELS FOR MINING SYSTEMS

**Ovako steel for mining systems covers a wide range of non-consumable components used within percussive and rotary drilling, as well as rock and ore processing. Our broad selection of grades is widely used wherever abrasive wear, fatigue or impact resistance is critical to component safety and performance.**

## **Cleaner steel enables higher productivity**

In the mining industry, safety and reliability are essential to profitable performance. Our range of steels has been designed, tested and crafted with exactly this in mind. Based on our decades-long heritage of pioneering carbon steel research and development, Ovako offers unmatched quality consistency and traceability from melt to melt. This high-precision chemical composition is key to ensuring superior wear, impact or fatigue properties for the specific load cases faced by your components. And the more percussive the environment, the more important the purity of the steel is to ensuring repeatable results in highly automated applications.

## **Safe and reliable design**

For manufacturers of rigs and other mining systems supporting the drilling and milling tools, we offer a wide range of grades and shapes that ensure maximum safety and reliability. Among manufacturers of hydraulic systems and components, Ovako has gained a leading reputation for supplying world-class tailored steel grades as well as long-lasting, cost-efficient Cromax piston steels.

## ROCK BOLT

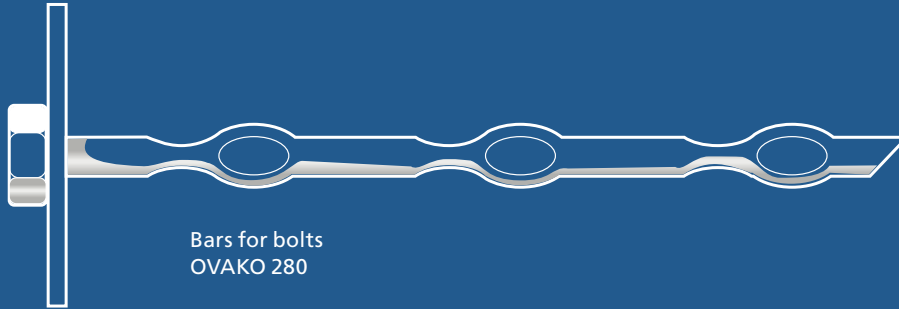

Bars for bolts  
OVAKO 280

## HYDRAULIC DRIFTER FOR TOP HAMMER SYSTEMS

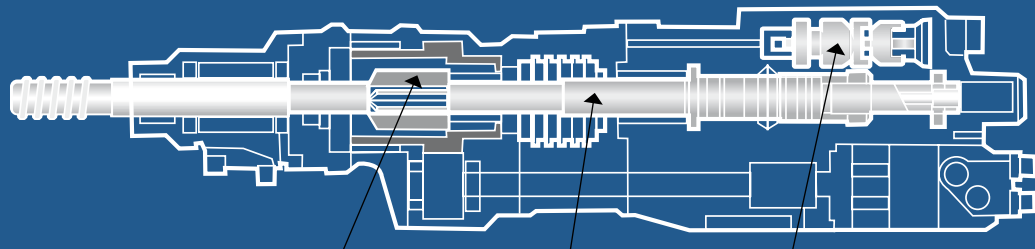

Bushings  
OVAKO 420, 253, 256

Piston  
OVAKO 528Q

Damping piston  
OVAKO 277Q, 398Q

## POINT ATTACK TOOLS IN CONTINUOUS MINERS



Tool holder in point attack tools  
Bars in WR-steels

## CONVEYORS IN CONTINUOUS MINING

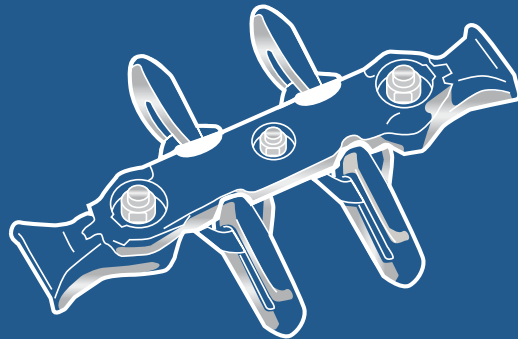

Chain and flight bar in armored face conveyors  
Bars in grade 23MnNiMoCr5-4

# TAILORED GRADES FOR CONSTRUCTION SYSTEMS

**Our steel grades for construction systems are ideal for all types of “drilling-like” applications used in civil construction works. These products are developed to withstand the heaviest imaginable wear or fatigue loads – or even a combination of the two.**

## **Optimized for complex loads**

Our expertise in this area is based on more than fifty years supporting the traditional mining industry with high quality steel. Today we apply this knowledge to similar construction applications ranging from hydraulic or pneumatic tools for demolition to other tearing applications. Our material knowledge is highly sought-after for product optimization or building new step-changing designs where complex load cases need to be handled with predictable and reliable performance. Our comprehensive testing program covers various types of wear resistance and isotropic qualities, together with highly machinable material properties.

## **Giving you full control – from mill to delivery**

We support a broad network of distributors worldwide, because we know exactly how important they are to your business, and to ours. Starting with the deep metallurgical knowledge of the experts in our mills, we work together with your distributor to ensure the exact properties you need. All to give you a competitive edge with enhanced productivity, customized component designs and the closest near-net shapes.



## HYDRAULIC BREAKERS

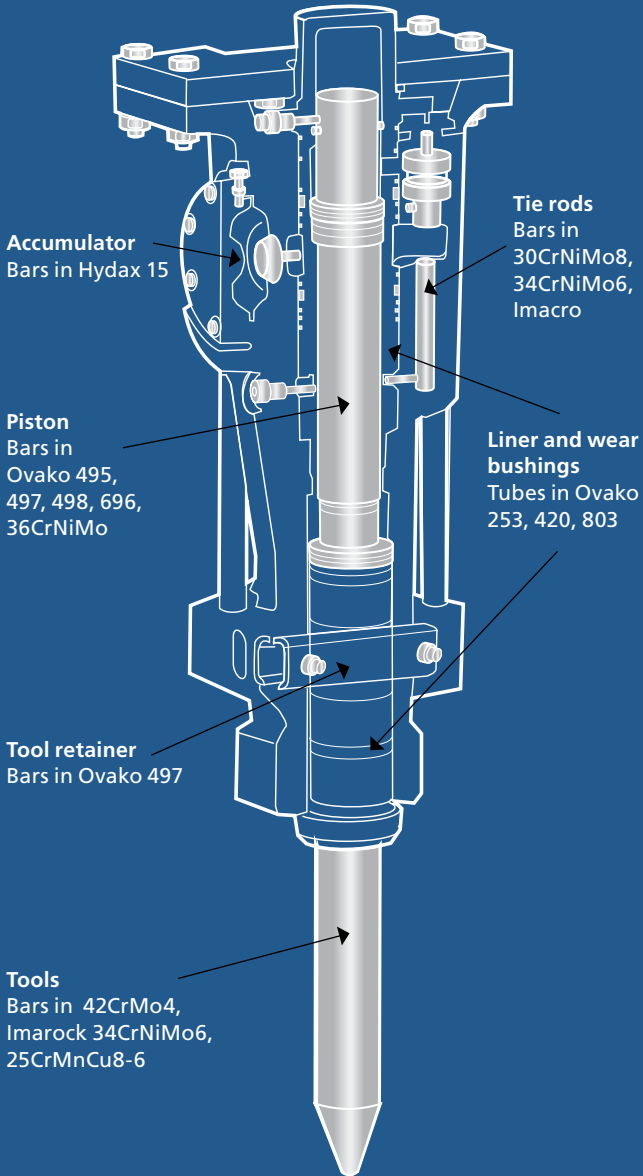

## HORIZONTAL DIRECTIONAL DRILLING, HDD

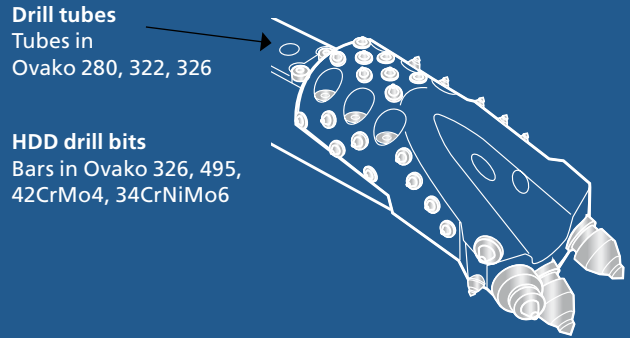

## TUNNEL BORING MACHINES, TBM

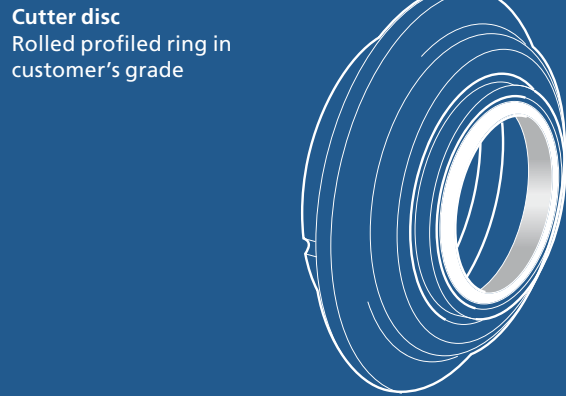

## AUGER DRILLING AND COLD MILLING MACHINES

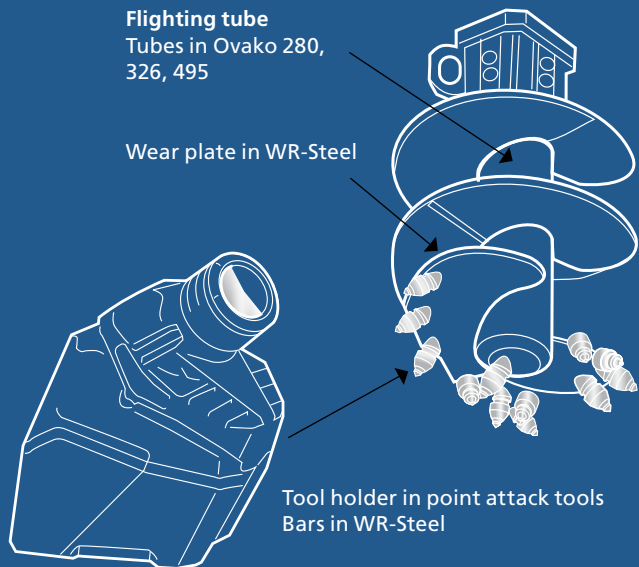

## OVAKO MINING AND CONSTRUCTION SYSTEMS STEEL GRADES

For further information about these and other Ovako grades, see our Steel Navigator on [ovako.com](http://ovako.com)

Chemistry (typical)					
Similar international standard	Specific Ovako grade	C	Si	Mn	S
	SB17M10B	0.17	0.25	1.0	
20MnB5	SB21M10B	0.21	0.25	1.0	
24MnB5F	SB24M13B	0.24	0.25	1.3	
27MnCrB5-2	SB27M12CB	0.27	0.25	1.2	
30MnCrB5-2F	SB30M12CB	0.30	0.30	1.2	
33MnCrB5-2	SB33M13CB	0.33	0.3	1.3	
38MnB5	SB38MnB5	0.38	0.3	1.3	
43MnB6-3F	SB43M14B	0.43	0.3	1.3	
4CrMn16-4	Imacro	0.04		1	
16Mn5	HYDAX 15	0.16		1.2	
19MV6	280M	0.18		1.45	
19MV6	280T	0.18		1.5	
19Mv6	280 / SB450	0.18	0.35	1.55	
19MV6	281T	0.2	0.35	1.6	
23MnNiMoCr5-4	9209	0.23	0.2	1.3	
EN27 / 23NiCrMo12-5	253A	0.22		0.7	
EN27 / 23NiCrMo12-5	253L	0.24		0.65	
EN27 / 23NiCrMo12-5	253S	0.23		0.72	
EN27 / 23NiCrMo12-5	4722	0.24		0.65	
EN27 / 23NiCrMo12-5	4734	0.23		0.68	
	256G	0.23		0.7	
300M	497Q	0.42		0.75	
30CrNiMo8		0.29		0.55	
34CrNiMo6	356D	0.35		0.72	
34CrNiMo6	6499	0.34		0.65	
42CrMo4	327A	0.43		0.75	
42CrMo4	6082	0.42		0.75	
48CrMo4-10F	495B	0.48		0.8	
48CrMo4-10F	6521	0.48		0.78	
50CrMo4	528E	0.52		0.75	
50CrMo4	528Q	0.52		0.75	
55NiCrMov7	696R	0.55	0.3	0.8	
100CR6 / 52100	803F	0.98		0.35	
100CR6 / 52100	803Q	0.96		0.35	
AISI 4130	322D	0.3		0.5	
AISI 4140	326C	0.4		0.95	
AISI 4340	355B	0.4		0.68	0.006
AISI 4340	6514	0.4		0.73	0.015
AMS 6481	398Q	0.33	0.25	0.55	
EN30B	498A	0.3		0.5	
EN30B	498Q	0.3		0.5	
	277L	0.15		1.3	
	277Q	0.15		1.3	
	5910 / Imarock	0.25	0.95	1.1	

Cr	Ni	Mo	Other elements	Attribute brand	Casting method
0.4			B	WR	CC
0.2			B	WR	CC
0.2			B	WR	CC
0.5			B	WR	CC
0.6			B	WR	CC
0.6			B	WR	CC
0.3			B	WR	CC
0.3			B	WR	CC
4		0.06		M	CC
			V	M	CC
0.4			V	M	CC
0.25			V	BQ	IC
			V		CC
0.2			V	BQ	IC
0.55	1	0.6			CC
1.3	2.9	0.24			IC
1.3	3	0.23			IC
1.31	2.9	0.24		BQ	IC
1.3	3	0.23			CC
1.33	2.58	0.23			CC
1.25	3.75	0.32		BQ	IC
0.82	1.85	0.37	V	IQ	IC
1.9	1.85	0.32			IC
1.45	1.45	0.25		BQ	IC
1.6	1.52	0.23			CC
1.1	0.2	0.25		BQ	IC
1.1		0.17		M	CC
1.12	0.46	0.96	V	BQ	IC
1.1	0.45	0.95	V		CC
1.05	0.21	0.21			IC
1.05		0.2		IQ	IC
1.2	1.65	0.5	V	BQ	IC
1.5				BQ /	IC / CC
1.5				IQ	IC
1		0.21		BQ	IC
1		0.2		BQ	IC
0.8	1.82	0.25	V	BQ	IC
0.85	1.7	0.23			CC
3		0.25	V	IQ	IC
1.32	4.05	0.22		BQ	IC
1.45	4	0.2		IQ	IC
2.2	0.5	0.5	V	BQ	IC
2.2	0.5	0.5	V	IQ	IC
1.8	0.3	0.17			CC

\*) IC = Ingot Cast  
CC= Continuous Cast

Ovako develops high-tech steel solutions for, and in cooperation with, its customers in the bearing, transport and manufacturing industries. Our steel makes our customers' end products more resilient and extends their useful life, ultimately resulting in smarter, more energy-efficient and more environmentally-friendly products.

Our production is based on recycled scrap and includes steel in the form of bar, tube, rings and pre-components. Ovako has around 2,700 employees in more than 30 countries. Ovako is a subsidiary of Sanyo Special Steel and a member of Nippon Steel Corporation group, one of the largest steel producers in the world with more than 100,000 employees globally.

For more information, please visit us at [www.ovako.com](http://www.ovako.com), [www.sanyo-steel.co.jp](http://www.sanyo-steel.co.jp) and [www.nipponsteel.com](http://www.nipponsteel.com).

---

## CONTACT US

---

[www.ovako.com/en/contact/](http://www.ovako.com/en/contact/)

